

INSTRUCTION MANUAL

PORTABLE MAGNETIC DRILLING MACHINE

Read this manual carefully before operating your Nitto Kohki Portable Magnetic Drilling Machine. Keep this manual with your machine. All users of the Nitto Kohki Portable Magnetic Drilling Machine must read this manual.

ATRA ACE Model WA-5000

Professional Tool

For One-Touch Type Annular Cutter Only
(Side-Lock Type Annular Cutter cannot be used.)

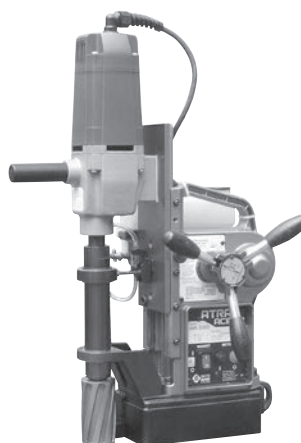

Specifications

Model		WA-5000
Power Source (Single Phase)		220-240V ~ 50/60Hz
Drill Motor	Rated Power Consumption	1150W
	Rated Current	5.4A
	No-load Speed	350/650min ⁻¹
	Load Speed	250/450min ⁻¹
Magnet Power Consumption		75W
Hole Capacity	JETBROACH One-touch type	12mm – 50mm dia. Plate thickness 75mm
	HI-BROACH One-touch type	14mm – 50mm dia. Plate thickness 50mm
Magnet Holding Power		9800N
Magnet Dimensions		101mm × 201mm
Weight		23kg
Short-Circuit Current Rating		5kA

The specifications and configurations contained in this document are subject to change without prior notice due to improvements we are making day in, day out.

Manufactured by :



NITTO KOHKI Co., Ltd.
2-9-4, Nakaikegami, Ota-ku,
Tokyo, 146-8555, Japan
Tel : (81)-3-3755-1111
Fax : (81)-3-3753-8791
E-mail : overseas@nitto-kohki.co.jp
URL : www.nitto-kohki.co.jp

Keep the manual handy – so you can use it whenever necessary.

Original Instructions

Thank you very much for your purchase of **Nitto Kohki product**.

Before using your machine, please read this manual carefully so that you may use it properly to get the most out of it.





Please keep the manual handy - so you can use it whenever necessary.

- **English** : Please ask your dealer or distributor for instruction manual in local language(s).
- **German** : Bitte fragen Sie Ihren Händler nach eine Betriebsanleitung in Landessprache.
- **French** : S'il vous plait, veuillez demandez á votre fournisseur de manuel instruction en langue locale.
- **Spanish** : Por favor, contacte con su distribuidor para el manual de instrucciones en español.
- **Portuguese** : Por favor pessa ao seo agente ou distribuidor o manual de instrucces ih linguagen local.
- **Italian** : Per Manuale Istruzioni in lingua locale Vi preghiamo di rivolgervi al rivenditore o distributore.
- **Dutch** : Vraag uw handelaar om een nederladstalige gebruiksaanwijzing.
- **Swedish** : Be er lokala Åtreförsäljare eller distributör om manualer pá svenska.
- **Danish** : Venligst henvend Dem til den danske distributør for instructions manualer.
- **Polish** : Proszę pytać swojego dealera lub dystrybutora o instrukcje obsługi w języku localnym.
- **中文** : 請向當地供應商或經銷商詢問中文使用說明書

CONTENTS



IMPORTANT SAFETY INSTRUCTIONS FOR ALL ELECTRIC TOOLS	2
IMPORTANT SAFETY INSTRUCTIONS FOR PORTABLE MAGNETIC DRILL	3
1. USAGE	6
2. CHECK THE CONTENTS OF THE PACKAGE	6
3. NAME OF PARTS	6
4. ELECTRIC CONTROL FUNCTIONS	6
5. PREPARATION	7
6. HOW TO OPERATE THE TOOL	10
7. TROUBLESHOOTING	12
8. MAINTENANCE AND INSPECTION	13
9. ORDERING SERVICE PARTS	14
10. ATRA ACE WA-5000 MOTOR ASSEMBLY AND PARTS LIST	16
11. ATRA ACE WA-5000 ASSEMBLY	17
12. ATRA ACE WA-5000 PARTS LIST	18

PICTOGRAM

	Using this tool improperly could result in serious injury. Read the instruction manual before using.
	Do not allow the main body or the power source to get wet as it will cause electric shock and leakage.
	Always wear suitable eye protection.
	Always wear suitable hearing protection.
	Always wear respiratory protective equipment (PPE).

- Sound Pressure Level :Maximum 85dB(A) according to Clause 1.7.4(f), Annex I, Machinery Directive.
- Sound Power Level :Maximum 98dB(A)
- Operating Temperature :5°C ~ 40°C
- Operating Humidity :Maximum 90% at 25°C
- Over-voltage Category :Category II according to IEC664-1
- Pollution Degree :Degree 3 according to IEC664-1
- Wiring Diagram No. :TZW0112

The following Safety notations are used throughout the manual to highlight safety precautions for the user and for the machine.

 DANGER:	Indicates an imminently hazardous situation which, if not avoided by following the instructions given, will result in death or serious injury.
 WARNING:	Indicates a potentially hazardous situation which, if not avoided by following the instructions given, could result in death or serious injury.
 CAUTION:	Indicates a potentially hazardous situation which, if not avoided by following the instructions given, could result in injury or material damage.

Caution: Important precautions for machine or tool setup, operation and maintenance.

WARNING

IMPORTANT SAFETY INSTRUCTIONS FOR ALL ELECTRIC TOOLS

When using electric tools, basic safety precautions should always be followed to reduce risk of fire, electric shock, personal injury and the like, including the following.

(1) Keep work area clean.

- Cluttered work areas and benches invite accidents and injuries.

(2) Consider work area environment.

- Do not expose tools to rain. Do not use tools in damp or wet locations.
- Keep work area well lit.
- Do not operate near flammable liquids or in gaseous or explosive atmospheres.

(3) Check the Power Source

- Operate under the power source the voltage fluctuating rate of which is within $\pm 10\%$ of the rated voltage, and the frequency of which is 50/60Hz of sinusoidal wave.

(4) Be cautious about electric shock.

- When using electric tools, do not touch any which is earthed. (Ex. Pipe, heating apparatus, microwave oven, outside frame of refrigerator)

(5) Keep children away.

- Also all visitors should be kept away from work area.
- Do not let visitors contact the tool, or connecting cords.

(6) Store idle tools.

- When not in use, tools should be stored in dry, and locked-up places out of reach of children.

(7) Do not force tool.

- It will do the job better and safer at the rate which it was designed.

(8) Use right tool.

- Do not force a small tool of attachment to do the job of a heavy-duty tool.
- Do not use tool for a purpose not intended.

(9) Dress properly.

- Do not wear loose clothing or accessories. They can be caught in moving parts.
- Rubber gloves and Non-skid footwear are recommended.
- Wear protective hair covering to contain long hair.

(10) Always wear suitable eye protection.

- Everyday eyeglasses only have impact resistant lenses. They do NOT protect eyes. Also use face or dust mask, if operations create dust.

(11) Do not abuse cable.

- Never carry tool by connecting cable or yank it to disconnect from receptacle.
- Do not place a cable near a place with high heat, oil, and sharp edge.

(12) Secure work.

- Use clamps or a vise to hold work when practical.
- It is safer than using your hand and it frees both hands to operate tool.

(13) Do not overreach.

- Keep proper footing and balance at all times.

(14) Cautious maintenance is necessary for electric tools.

- Always maintain blades and keep it work well so that safe and efficient work can be done.
- Follow the instruction manual for oiling or change of accessories.
- Check the cable regularly. Contact the sales agents to repair it when it is defective.
- When an extension cable is used, check regularly and change it when it is damaged.
- The grip should be kept dry and clean. Maintain it so well that it does not carry oil or grease.

(15) Switch off and take off the plug for the following:

- Not in use.
- When you change blades, grinding stone and bit.
- Any danger is anticipated.

(16) Remove spanners, wrenches etc., after adjustment.

- Make sure that spanners, wrenches etc., which are used for adjustment are removed before switching on.

(17) Always avoid unexpected start.

- Do not carry the tool with a finger on the switch when the power supply is on. Make sure that the switch is off before plugging in.

(18) Use a cabtyre cable or a cabtyre extension cable when it is used outside.

(19) Stay alert.

- Watch what you are doing.
- Bear in mind the way of handling/operation and the circumstances of the surrounding area.
- Use common sense.
- Do not operate tool when you are tired.

(20) Check damaged parts.

- Before further use of the tool, an accessory or other part that is damaged should be carefully checked to determine that it will operate properly and perform its intended functions.
- Check for alignment of moving parts, binding of moving parts, breakage of parts, mounting and any other conditions that may affect its operation.
- An accessory or other part that is damaged or inoperable should be properly repaired or replaced. When a switch becomes out of order, repairs should be performed only by the sales agent from whom you purchased the tool or an authorized dealer.
- Do not use electric tools which cannot be activated or stopped with a switch.

(21) Use recommended accessories.

- Consult this manual or the sales agent from whom you purchased the tool or an authorized dealer for recommended accessories. The use of improper accessories may cause risk of injury to persons.

(22) Repairs by authorized personnel.

- This tool should not be modified as it meets safety requirements.
- Any repairs to the tool or installation of replacement parts should be performed only by the sales agent from whom you purchased the tool or an authorized dealer.
- Failure to utilize the expertise of the sales agent from whom you purchased the tool or an authorized dealer or, failure to use genuine replacement parts, may result in an increased risk of injury to the user and may invalidate your warranty.

- Use of power is limited to the power source specified by the rating plate.
- Do not use the power supply for the engine powered welder.
- The earth lead must not be connected to a gas pipe. This may cause an explosion.
- Make sure the Earth Clip and Earth Lead are not faulty. If you have a tester or insulation resistance meter, check for continuity between the Earth Clip and the metal part of the body. Burying an earth rod or earth plate in the ground and connecting the Earth Lead is a job for a qualified electrician so you should consult a nearby electrical contractor.
- Before using the tool, make sure the power source to which it will be connected is fitted with an earth leakage breaker to prevent electric shock.
- Do not open Switch Plate.
- Socket-outlet shall be installed near the equipment and shall be easily accessible.
- Extension cord should be selected after ensuring the diameter is compatible with the length of the extension. Beware of extremely long power cord (particularly wound up thin cords) as they may cause drops in voltage which weaken the magnetism, adversely affecting the performance and function of the tool. Do not share the extension cord with any other electric machine tools. (Fig. 1)

Extension Cable	
Max. Length	Nominal cross-sectional area
10 m	1.25 mm ² or more
15 m	2.00 mm ² or more
30 m	3.50 mm ² or more

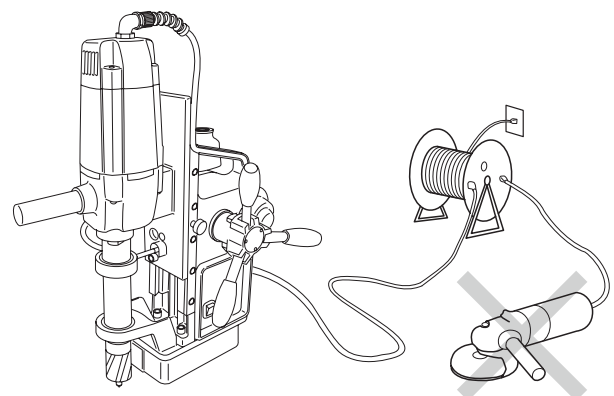

(Fig. 1)

⚠ WARNING

**IMPORTANT SAFETY INSTRUCTIONS
FOR PORTABLE MAGNETIC DRILL**

- **When performing maintenance, inspection, replacement or adjustment of parts, make sure to disconnect the plug from the receptacle.**

- **Do not operate on the ceiling.** The tool should be operated on a horizontal place or the wall (vertically). Do not operate the tool on the ceiling (upside down). (Fig. 2) Never use this unit at the work on ceiling (upside down).

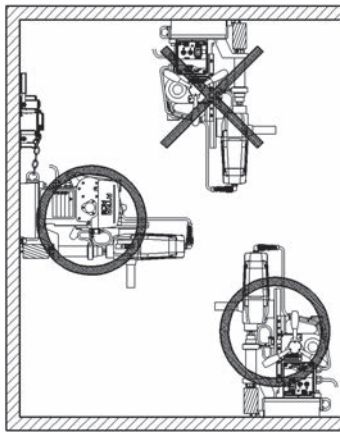

(Fig. 2)

- **Minimum workpiece thickness of 9mm.** If a workpiece is not thick enough, it will weaken the magnetism, preventing proper operation due to the slipping or lifting from the workpiece. When drilling a workpiece of insufficient thickness, it is recommended that a piece of iron, approximately 10mm thick and somewhat larger in size than that of the Magnet, be placed on the reverse side of the workpiece. (Fig. 3, Fig. 4)

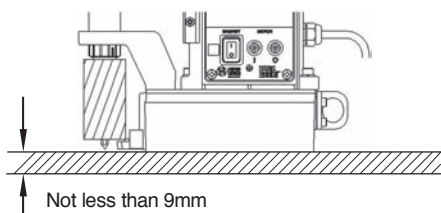

(Fig. 3)

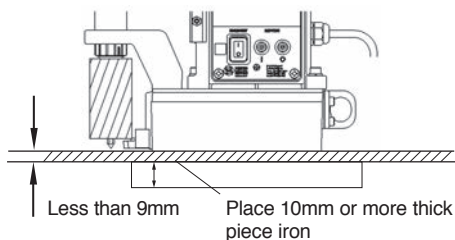

(Fig. 4)

- **Clean the adhesion surface of the Magnet and the surface of the workpiece.** Any gaps between the adhesion surface of the Magnet and the surface of the workpiece will weaken the adhesive power of the Magnet and may cause the tool to swing around. Therefore the surfaces should always be kept clean

and free from metal chips, bumps and depressions or rust. Also, do not place the Magnet over holes as this will also weaken the adhesion.

- **Use the Chain to prevent the tool from falling.** Use the included Chain to attach the tool to the workpiece where there is a risk that it might fall from a high place or tip over if the Magnet lifts off during a power stoppage or for some other reason. Use Supporting Magnet Assy (option) to prevent main body of unit from falling when the chain can not be wound around work because its size is too large to wind.

(Fig. 5)

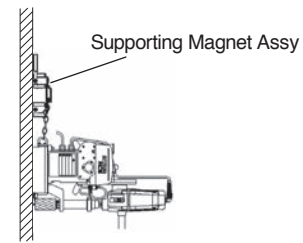
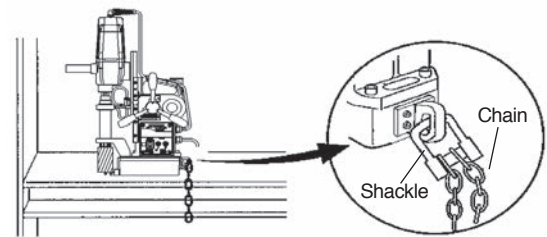

(Fig. 5)

- **Align the Magnet parallel to the length of the workpiece.** Since the surface of an H-section is normally curved as shown in Figure 6, the Magnet should be placed parallel to the length of the workpiece to ensure good adhesion and safe working. Insecure magnetic adhesion is the cause of cutter damage and unexpected accidents. (Fig. 6, Fig. 7)

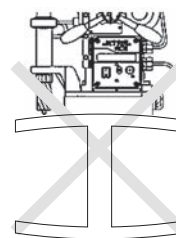

(Fig. 6)

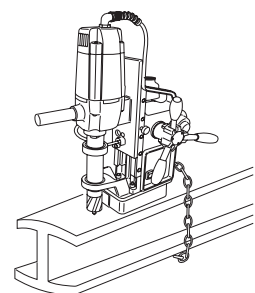

(Fig. 7)

- **5 hours is the maximum continuous operating period for the Magnet. And 30 minutes is the rated operating period for the Drill Motor.**

When not in operation, keep the machine on appropriate clean flat surface with the Magnet Switched off.

- **Do not touch the rotating cutter or swarf with your hands, body, gloves, hair or clothes.**

- **Beware of slag being ejected when a hole is finished.** Wear protective gear since slag (metal chips) is ejected with great force when a hole is finished. Do not allow unprotected people to approach the work site. When working in high places, make sure there is no one underneath and be very careful of falling slag. The slag is hot, do not touch it with bare hands.
- **When clearing away metal chips, set the Magnet Switch to Off.** Do not touch the chips with your hands, use a rod such as a screwdriver to remove them.
- **When replacing cutters, do not touch the cutting blades with bare hands.**
- **You must use a Pilot Pin which matches the cutter.**
Pilot Pins differ according to cutter type, diameter and length (depth). An accident may be caused if the cutter and Pilot Pin combination is wrong.
Refer to item 5-4 cutter and Pilot Pin Combinations.
- **Do not use Cutting Oil for other purposes.**
Refer to item 5-6 Preparing the Cutting Oil.
- **Do not remove labels or name plates from the tool.**
Contact the sales agent from whom you purchased the tool or an authorized dealer if a label or name plate is damaged or missing.
- **When you put the machine back to the carrying case, please make sure to let out the cutting oil from Oil Tank, and also to remove Side Handle from the motor.**

CAUTION

- **Set the Magnet Switch to Off before connecting the Power Plug to a power source.**
- **Non-magnetic (aluminum, stainless steel, copper alloy, etc.) workpiece can not be used since the Magnet will have no adhesion to it.**
- **Do not use this tool on steel which is being electric welded.** If the earthing in electric welding is inadequate, electricity will flow through the Magnet causing irreparable damage to the electric parts and may cause an accident due to faulty operation.
- **Do not apply excess force on feed during manual drilling.** HI-BROACH and JETBROACH have thin cutter blades with lower cutting resistance than twist drills. Therefore they should not be fed forcibly manual drilling. Be careful because if more than necessary force is used the cutters will be damaged and their useful life will be shortened.
- **Do not switch from manual to automatic operation while drilling holes.** If you wish to drill a hole using automatic feed, start with automatic feed. If you are drilling a hole with manual feed and switch to automatic feed in the middle, the Drill Motor may stop.
- **When the automatic feed is On, do not feed manually.**
With automatic feed on (with the Rod Handles pushed towards the body), do not put additional feed pressure on the Rod Handles.

1 USAGE

This is a machine tool which attaches magnetically to mild steel and uses the power of Drill Motor to drill holes with JETBROACH One-touch type or HI-BROACH One-touch Type.

2 CHECK THE CONTENTS OF THE PACKAGE

Check the contents and make sure that the tool is not damaged due to an accident during the transportation, if any. The contents should correspond to the list as follows. Just in case there are some damaged or missing parts, contact the sales agent from whom you purchased the tool or an authorized dealer.

THE CONTENTS OF THE PACKAGE AND ACCESSORIES

WA-5000

Package Contents	Q'ty	check
ATRA ACE	1set	
Pilot Pin 08050	1	
Hex. Socket Screw Key 3	1	
Hex. Socket Screw Key 4	1	
Spanner 8x10	1	

Package Contents	Q'ty	check
Cutting Oil 0.5 ℓ Can	1	
Side Handle	1	
Chain	1	
Guard	1	
Instruction Manual	1	

3 NAME OF PARTS

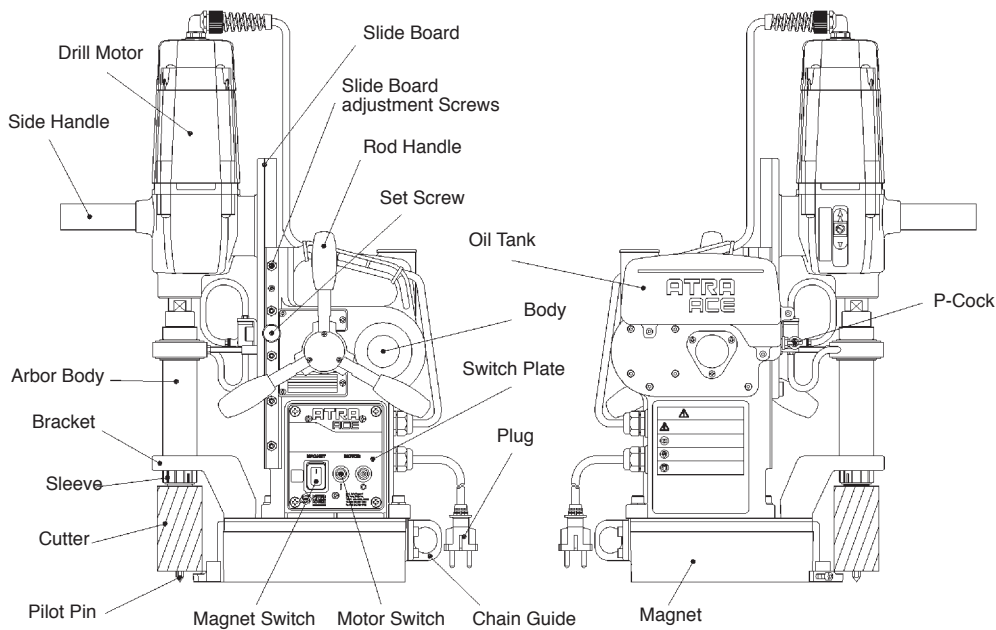

(Fig. 8)

4 ELECTRONIC CONTROL FUNCTIONS

4-1 Load Detector

If there is an overload during drilling, the following functions are automatically activated. The load detector may not function properly if the power supply is an engine generator or the supply voltage is too high or too low.

(1) Automatic Feed Control Function

This system automatically controls the feed rate where several seconds after start-up of the drilling it automatically slow down the feed and then the rate varies depending on the load condition of the Drill Motor.

The feed rate is also automatically regulated according to the cutter diameter.

(2) Overload Stop Function

Both the drilling and feeding operations stop automatically whenever there is an excessive load on the Drill Motor, preventing the Drill Motor and cutter from break. If the cutter is dull, however, breakage may be inevitable.

4-2 Cycle Stop Function

After the cut has finished, a detector responds to the reduction in load and both the drill and the feed motor automatically stop.

4-3 Limit Switch Function

Even in case the automatic stop function fails at the end of the drilling allowing the Drill Motor to continue downward feed, the Limit Switch stops both the drilling and feed when the stroke reaches its lower limit.

4-4 Side Slip Detection Function

If the Magnet slides off while drilling holes, the Drill Motor will stop and the feed will stop.

4-5 Restart Prevention Function

- When a power failure has occurred while the tool was being used, the restart prevention function operates when the power is restored.
- Even when the drill stops during operation because of the interruption of the power supply or accidental unplugging of the power supply and the power supply resumes, or is plugged, the indicator lamps are lit and the magnet regains its attracting power, but the Drill Motor does not rotate.
- To resume work, set Switch to the Magnet On and then the Motor Switch to On, and the Drill Motor will start.

5 PREPARATIONS

⚠ WARNING

When making preparations, set the Magnet Switch to Off and remove the Power Plug from the power supply.

5-1 Accessory Installation

The Side Handle, an accessory, should be mounted on the Drill Motor.

When you carry the machine to other spots, please hold up the machine with the grip of the machine and the Side Handle of the Drill Motor.

5-2 Cutter Usage

⚠ CAUTION

- Cutters other than one-touch type can not be used.
- For better working and greater safety, do not use worn or broken cutters.

5-3 Cutter Precautions

When you need one-ouch type cutters or accessories, refer to 9. Ordering Service Parts.

5-4 Cutter and Pilot Pin Combinations









⚠ WARNING

You must use a Pilot Pin which matches the cutter.

Pilot Pins differ according to cutter type, diameter, and

length (depth). An accident may be caused if the cutter and Pilot Pin combination is wrong.

- Match the appropriate Pilot Pin to the cutter which is to be used. (Fig. 9)

PILOT PIN		HI-BROACH Cutters	
06025	PN:TK01167 6.35 dia. 81 mm	HBO 14 - 17 dia. Depth 25 mm	
08025	PN:TJ12696 8 dia. 76 mm	HBO 17.5 - 50 dia. Depth 25 mm	
06050	PN:TK01166 6.35 dia. 112 mm	HBO 14 - 17 dia. Depth 50 mm	
0850	PN:TK00802 8 dia. 100 mm	HBO 18 - 50 dia. Depth 50 mm	
08050	PN:TJ16019 8 dia. 112 mm		
PILOT PIN		JETBROACH Cutters	
06025	PN:TK01167 6.35 dia. 81 mm	JBO 12 - 17 dia. Depth 25 mm	
08035	PN:TJ15859 8 dia. 91 mm	JBO 17.5 - 40 dia. Depth 35 mm	
06050	PN:TK01166 6.35 dia. 112 mm	JBO 12 - 17 dia. Depth 50 mm	
08050	PN:TJ16019 8 dia. 112 mm	JBO 17.5 - 50 dia. Depth 50 mm	
08075	PN:TJ17436 8 dia. 133 mm	JBO 17.5 - 50 dia. Depth 75 mm	

(Fig. 9)

- Pilot Pins differ according to the type, diameter and length (depth) of the cutter. If the cutter and Pilot Pin combination is wrong, the cutter will be damaged due to failure to eject the slag (metal chip) or poor Cutting Oil supply.
- Unspecified usage not only significantly reduces the life of the cutter but also damage the cutter and lead to unexpected accidents.

5-5 Mounting and Dismounting the Cutter

⚠ WARNING

- Do not touch cutting blades with bare hands.

(1) Raise the Drill Motor by turning the Rod Handles in the clockwise direction. (Fig. 10)

(2) Take the Pilot Pin which suits the size of cutter to be used and insert the Pilot Pin in the cutter. (Fig. 11)

(3) Align the depression in the cutter with the white line on the Sleeve and insert the cutter. (Fig. 12) When the cutter is pushed right in, the Sleeve can be turned to the right and will lock into place with a click.

※ If the cutter will not go in, turn the Sleeve to the left and try again.

(4) To remove the cutter, turn the Sleeve to the left and pull out the cutter. (Fig. 13)

1) Pull down out of the body

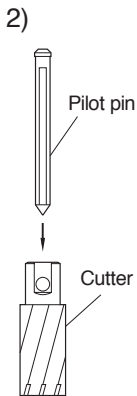
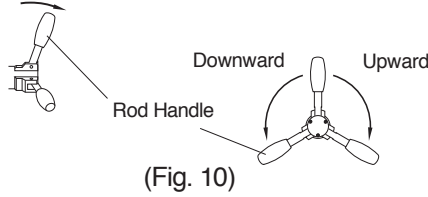

(Fig. 11)

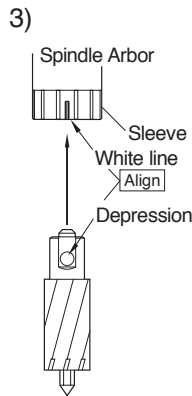

(Fig. 12)

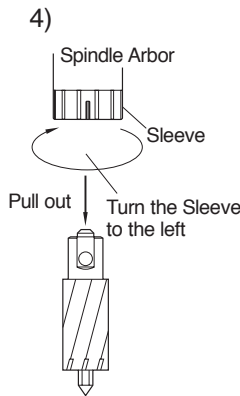

(Fig. 13)

5-6 Preparaion of Chip Breakers

⚠ WARNING

- Set the Chip Breaker so that the tips of the blade may not interfere with the cutter both at the top and bottom in setting up the Chip Breaker.

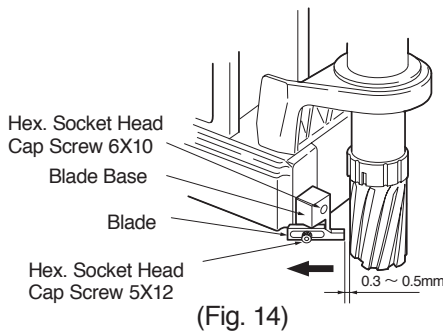

(Fig. 14)

Chip Breaker is to shred down cutting chips in randomly short length that are produced during the drilling operation for easy discharge of the succeeding cutting chips.

Setting the blade (see the fig.14)

(1) Mounting the cutter

Loosen the Hex. Socket Head Cap Screw and retract the Blade in the arrow direction until it can not retract any further, and then mount the cutter.

(2) Setting the blade

Set the Blade with the gap between the cutter and tip of the blade being 0.3mm to 0.5mm, securely mount it

on the Blade Base with the hex. socket head cap screw.

5-7 Setting the Change Knob

⚠ CAUTION

- Change gear only after switch off the line and stop rotation.
- Slide the change knob to the end. If the slotted head screw projects from the change knob, the gear change condition is insufficient and gears may be broken. Before operation check this point. (Fig.15)

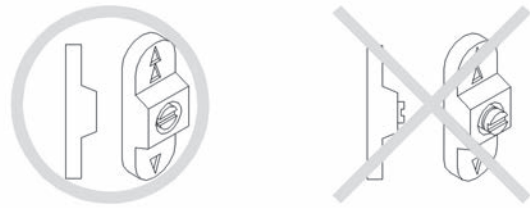

(Fig. 15)

Change the drill speed to suit the type and size of the cutter. (Fig.16)

Rotation	Hi Speed 650min ⁻¹	Low Speed 350min ⁻¹
Position of drill speed		
Cutter	JETBROACH One-touch Type 12mm – 39mm dia.	JETBROACH One-touch Type 40mm – 50mm dia.
	HI-BROACH One-touch Type 14mm – 19.5mm dia.	HI-BROACH One-touch Type 20mm – 50mm dia.

5-8 Preparing the Cutting Oil

Safety Notes on Cutting Oil should be observed.

⚠ WARNING

(1) Application and Usage Limitations

- Use only as cutting fluid. Not for use in ordinary households.

(2) Precautions on Handling Cutting Oil

- This liquid contains amines. It should not be mixed with rust preventives containing nitrite.
- May cause inflammation if it enters the eyes. Protective eye-wear should be used when handling to prevent entry into the eyes.
- Skin contact may cause inflammation. Protective gloves should be worn when handling to prevent contact with the skin.

- May cause discomfort if mist or vapor is inhaled. Breathing apparatus should be used when handling so that mist or vapor should not be inhaled.
- Dilution should be carried out in accordance with the Instruction Manuals.
- Keep it out of reach of children.
- Do not drink it.

(3) Emergency Treatment

- If it has entered eyes, immediately open the eyelids as wide as possible and wash thoroughly with water for at least 15 minutes. If there is inflammation, consult a physician and follow the instructions.
- If it has contacted the skin, wash immediately with soap and water. Soiled clothing should be removed and laundered thoroughly before re-use. If there is inflammation, consult a physician and follow the instructions.
- If mist or vapor has been inhaled, immediately transfer the patient to fresh air, cover his/her body with a blanket and keep warm and quiet. Consult a physician and follow the instructions.
- If it has been ingested, immediately give copious water and induce vomiting. Consult a physician and follow the instructions. If the patient is unconscious, do not administer water or induce vomiting.

(4) In Case of Fire

- For a fire in the vicinity, wear protective equipment and extinguish the fire approaching from the windward side with foam, powder or CO₂ fire extinguishers.

(5) Method of Storage

- Seal after use to prevent admixture with dirt and/or water.
- Store in a cool dark place away from direct sunlight and rain.

(6) Method of Disposal

- Disposal of undiluted and diluted fluid should be handled as waste fluid in accordance with the law by a waste disposal specialist.
- Wash water should be treated by pH adjustment, flocculation and settling, activated sludge treatment, activated carbon absorption, etc., and discharged in accordance with municipal standards.
- Since empty containers contain dregs, they should be handled with care.

(7) Other

- If transferred to other containers for use, the names of chemicals used in the workplace and the labeled contents should be displayed and kept together with

the Instruction Manuals ready for immediate perusal.

- Anyone wishing to have further details may request product safety data sheets from manufacturer.
- The inscribed details are based on currently available information and data and updated by new knowledge.
- Items to be noted are aimed at normal handling. Where special handling is involved, safety measures appropriate to the application and method of handling should be implemented.
- The inscribed details are submitted for your information and do not imply assurances or acceptance of responsibility.

5-8-1 Preparing the Cutting Oil

(1) Use Nitto genuine blue Cutting Oil.

Cutting performance and life may be reduced when other Cutting Oils are used.

(2) Dilute the Cutting Oil in the proportion of eight to ten times with tap water.

Do not use well water for dilution.

(3) Remove Rubber Cap from Oil Tank.

Fill in Oil Tank with Cutting Oil to the sideline on the Tank. Careful not to spill the oil on the machine.

5-8-2 Oil Flow Control

After installed cutter and Pilot Pin, press the Pilot Pin on to the workpiece, and oil flow starts when P-Cock is opened. Such flow is recommended that the cutter chips be kept constantly wet during drilling and free from discoloration due to overheat burn. Drilling without enough oil causes longer cycle time and shorter cutter life.

5-9 Inserting the Power Plug into the Power Source

CAUTION

Set the Magnet Switch to Off before inserting the Power Plug.

The power supply voltage used must be correct.

6 HOW TO OPERATE THE TOOL

WARNING

Wear the safety goggle while working. If much dust is produced, wear a dust mask.

6-1 Start and Stop

(1) Magnet On

Set the Magnet Switch to On the Magnet will activate.

(Fig. 17)

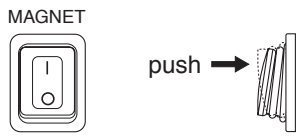

(Fig. 17)

(2) Drill Motor On

Set the Motor Switch to On . The Drill Motor will start.(Fig. 18)

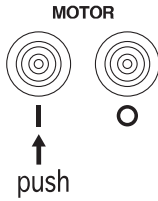

(Fig. 18)

! CAUTION

Drill Motor will start only when the Motor Switch is turned on after Magnet is activated.

(3) All Stop

When the Motor Switch is set to off, the Motor will stop. When the Magnet Switch is set to the Off position, the magnet will be deactivated and all functions will stop.

6-2 Drilling Procedure

(1) Punching

The punch hole should be vertical with respect to the workpiece and rather large in size. Precisely place the punch hole since it serves as a drilling guide. (Fig. 19)

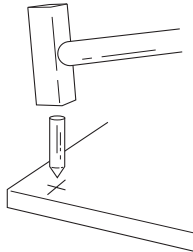

(Fig. 19)

(2) Make sure that both the magnet adhesion surface and the workpiece surface are clean.

! CAUTION

If something is caught under the magnet, there is a danger that the machine may slide off.

Gaps between the magnet adhesion surface and the workpiece weaken the magnetic holding power. Always keep the magnet adhesion surface free from foreign matter (such as metal chips), unevenness, and rust.

(3) Align with punch hole

Turn the Rod Handles gently in the counterclockwise direction to lower the cutter and align the tip of the

Pilot Pin with the punch hole. (Fig. 20)

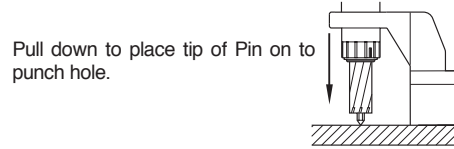

(Fig. 20)

(4) Magnet on

! CAUTION

Make sure the magnet is clinging to the workpiece.

Set the Magnet Switch to On and the magnet will be activated. (Fig. 21)

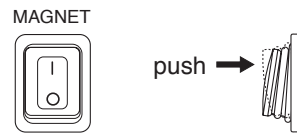

(Fig. 21)

(5) How to attach the Guard

Please attach the guard as shown in Fig.22.

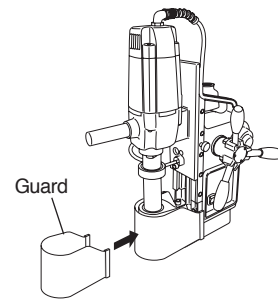

(Fig. 22)

(6) Oil Flow Control

After installed cutter and Pilot Pin, press the Pilot Pin on to the workpiece, and oil flow starts when P-Cock is opened. Such flow is recommended that the cutter chips be kept constantly wet during drilling and free from discoloration due to overheat burn. Drilling without enough oil causes longer cycle time and shorter cutter life.

(7) Drill Motor on

! CAUTION

Do not touch the rotating parts.

Set the Motor Switch to On . The Drill Motor will start. (Fig. 23)

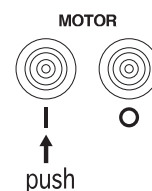

(Fig. 23)

(8) Automatic feeding

⚠ CAUTION

- Once it has started feeding, do not touch the Rod Handles until the drilling is finished.
- Do not use automatic feed if the finish side is slanted.

Push the Rod Handles towards the body to activate the automatic feeding. The feed in the first stage of the cutting operation is automatically slow and manual feed is not required. (Fig. 24)

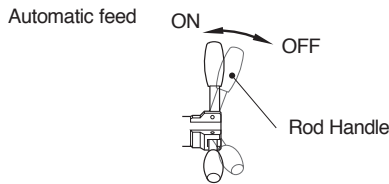

(Fig. 24)

When drilling a hole in an angle, channel or H-section, etc., the cutter may be damaged when it comes to a slanted or radiused surface on the finish side. Feed slowly in the start and finish. (Fig. 25)

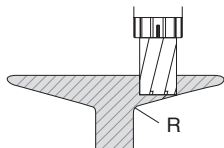

(Fig. 25)

(9) Finish the hole

⚠ CAUTION

Beware of ejected slag when finish the hole. Never touch the slag with bare hands since they are hot and sharp.

When the drilling is finished, the Drill Motor will stop. When it has stopped, pull the Rod Handles to outside and turn to clockwise and lift up the Drill Motor to the upper limit. Then quickly set the Magnet Switch to Off. If you fail to do this, the magnet is kept activated and shorten its life. (Fig. 26)

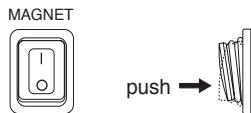

(Fig. 26)

(10) Slag removal

Do not start the next drilling with slag remaining in the cutter.

When the drilling is completed, the spring loaded Pilot Pin automatically ejects the slag. If, however, the slag does not eject and the cutter is clogged with the slag, the subsequent drilling will fail. In this case, remove the slag by hitting its flange with a thin punch. (Fig. 27)

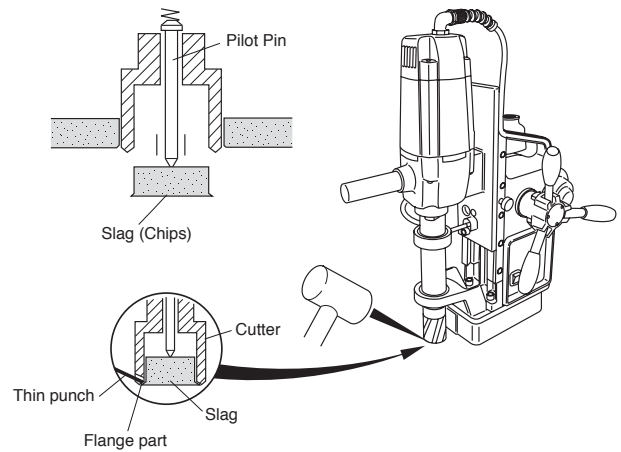

(Fig. 27)

6-3 Use Manual Feed for Elongated Holes

⚠ WARNING

Always use manual feed for making elongated holes and work slowly.

- Elongated holes should be drilled in sequence of ①→②→③. Holes ② and ③ should be drilled manually without excessive pressure on the cutter. Avoid drilling elongated holes with automatic feed since it may cause the cutter to break or cause unexpected accidents. File away any excesses.(Fig. 28)

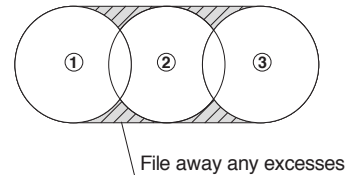

(Fig. 28)

- When making elongated holes, be sure to have the Pilot Pin positioned on the workpiece before cutting next holes.

6-4 Use Manual Feed for Drilling Laminated Plates

⚠ CAUTION

- Always use manual feed for drilling laminated plates and work slowly.
- Laminations must be clamped together securely.
- When drilling laminated plates, raise the cutter after the top plate has been drilled and remove the slag (metal chip) from the hole. Then drill the lower plate.
- Leaving the slag (metal chip in the hole) will cause the cutter to slide around and eventually lift the magnet off.

7 TROUBLESHOOTING

WARNING

- Do not attempt to repair the tool by yourself. This will cause damage to the tool and danger to yourself when you use it again.
- If any of the following, or other symptoms occur, or if there are other matters concerning usage that you do not understand, please consult the sales agent from whom you purchased the tool or an authorized dealer.

This tool is controlled by electronic preset functions and will stop automatically if the electronic control system malfunctions due to power line noise. During drilling, the following symptoms are not considered to be problematic. For safety reasons, check the tool only after ensuring the switch is set to Magnet On, the Rod Handles are pushed outside, and the automatic feeding is Off and the Drill Motor is lifted up:

Troubleshooting

Finding	Possible Causes	Corrective Action
The lamp does not light up even Magnet Switch is turned on.	Power line of the machine is not connected to the wall outlet securely.	Connect power line.
Drill does not start even Magnet Switch is turned on and the lamp lights up.	Electro-Magnet does not have the holding power (somehow, the coil is cut off).	Replace the faulty Magnet part.
	Limit Switch cuts off the power to the drill.	Pull up the Slide Board to in-activate the Limit Switch.
The machine drifts away when it starts cutting.	Workpiece is too thin and no enough magnet holding power.	Put back-up steel plate.
	Chip or swarf is held between Magnet and workpiece.	Clean the sole of Magnet.
Drill stops during the cutting operation.	The cutter is heavily worn out or broken.	Replace with a new cutter.
	Using non Nitto brand cutter.	Replace with a Nitto cutter.
	Chips does not come out due to deep holes (thick plate).	Set up the optional Chip-Breaker.
	Coolant flow is poor.	Adjust to supply enough coolant.
	Non Nitto coolant is used.	Change to Nitto coolant.
	Changed to manual feed in the middle of auto operation. *1	Start with auto feed.
	Cutting done with manual feed.	Slow down the manual feed speed.
Drill does not stop after the hole cut is finished.	Limit Switch is activated.	Reset the Limit Switch pointer to the correct position.
	Resumed cutting towards the end of the operation.	O.K. with the machine *2
Stopped in the middle of the cutting, and restarted but does not cut into and stop again.	Cutting with twist drill.	Cut with manual feed.
	Chips in the hole prevents the cutter edge come into contact with workpiece.	Take out the chips from the hole and resume cutting.

Note : *1 The circuit detects load during manual feed, and then no-load in the next short period until the clutch is engaged for auto feed and thus it considers the cutting is finished.

*2 The cutting after reset does not give the circuit enough load signal and thus it considers still being in cutting mode and drill is kept feeding down. But do not worry as the Limit Switch will turn off the drill at the bottom position.

8 MAINTENANCE AND INSPECTION

⚠ WARNING

Switch off and remove the power plug from the power supply during maintenance and inspection.

⚠ CAUTION

Check all attached parts periodically for loose screws. Securely tighten any loose screw.

8-1 Tighten the Set Screw when the tool is not in use

For safety reasons, when the tool is not in use or when the drilling operation is suspended, keep the Drill Motor from moving downward due to its dead weight by tightening the stopper set screw with the Drill Motor in an elevated position. If the Drill Motor is left down, the Pilot Pin or cutter may be damaged during transit.

(Fig. 29)

8-2 Greasing of sliding surfaces

From time to time, the sliding surfaces between the body and the Slide Board should be greased. (Fig. 29)

8-3 Loose Slide Board adjustment

Any looseness between the body and the Slide Board will adversely affect drilling precision, leading to premature wear on the cutter. When looseness is encountered, eliminate it by uniformly re-tightening the four Slide Board adjustment screws on the lateral side of the body to the extent that the Drill Motor will not fall under its dead weight. The screws are designed to work as a double-lock, so they should be securely tightened by turning the nuts. Do not adjust using the Set Screws. (Fig. 29)

8-4 Inspection of the Bracket

The Bracket which supports the Spindle Arbor is of key importance in maintaining drill precision. The Bracket is tightened by three screws, which should be inspected from time to time to ensure they are tight.

(Fig. 29)

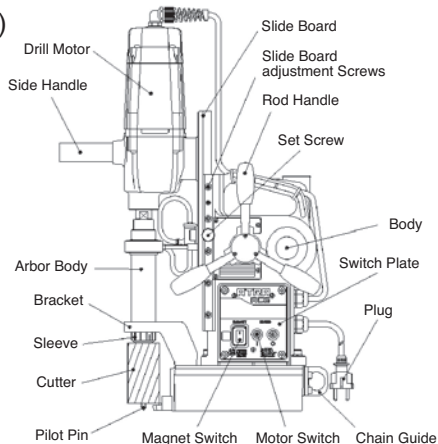

(Fig. 29)

8-5 Sharpening of Pilot Pin tip

If the Pilot Pin tip is dull, the pin will not be able to fit itself into the punching hole, causing poor drilling precision. It should be inspected from time to time, and, if the Pilot Pin tip is found to be dull, sharpen the tip or replace with a new one. Exercise caution during the sharpening operation as any rough grinding softens the tip due to annealing, even to the point of disabling it in some cases. (Fig. 30)

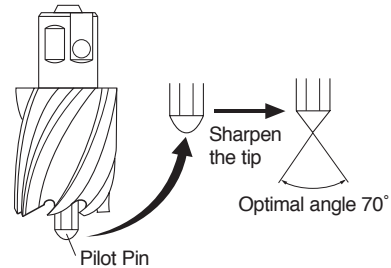

(Fig. 30)

8-6 Loosen a tight Pilot Pin

When the cutter needs to be replaced, pull out and change the Pilot Pin which acts as a guide. However, if Metal chips are caught between the cutter and the pin, the pin may be difficult to be pulled out. Tap the end of the pin gently with a wooden mallet as you pull it out. (Fig. 31)

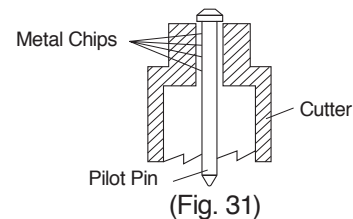

(Fig. 31)

8-7 Cutter grinding

When the cutter needs re-grinding, consult the sales agent from whom you purchased the tool or an authorized dealer.

8-8 Inspecting and replacing Carbon Brushes

The worn condition of the Carbon Brushes should be inspected periodically.

Commutation will deteriorate when the remaining length is about 8mm and may cause a breakdown so the brushes should be replaced in accordance with the following procedure. (Fig. 32)

- (1) Remove the Cap on the Drill Motor with a screwdriver. (Fig. 32)
- (2) Remove the worn brush, replace it with a new one and refit the Brush Cap. (Fig. 33)
- (3) After replacement, run the tool under no load for about ten minutes.

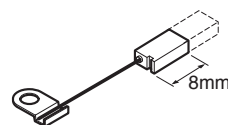

(Fig. 32)

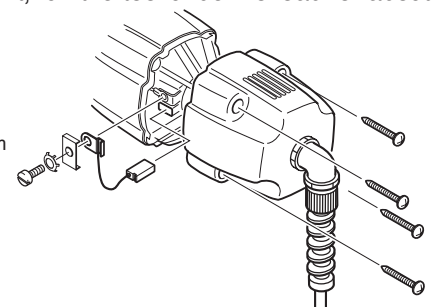

(Fig. 33)

9 ORDERING SERVICE PARTS

In ordering parts and components from the sales agent from whom you purchased the tool or an authorized dealer, give each part number, parts name and quantity required.

9-1 Genuine Cutting Oil

⚠ CAUTION

Use our Genuine Cutting Oil.

Part No.	Part Name
TB02621	Water-soluble Cutting Oil 2 ℓ (Light Blue)

9-2 Pilot Pin

⚠ CAUTION

Whenever you buy a cutter, should also buy a Pilot Pin to suit.

(metric sizes)

Part No.	Part Name	Depth(mm)	Applicable cutter (mm)
TK01167	Pilot Pin 06025	25	Hi-broach 14 - 17 dia. Jetbroach 12 - 17 dia.
TJ12696	Pilot Pin 08025		Hi-broach 17.5 - 50 dia.
TJ15859	Pilot Pin 08035	35	Jetbroach 17.5 - 40 dia.
TK01166	Pilot Pin 06050	50	Hi-broach 12 - 17 dia. Jetbroach 12 - 17 dia.
TJ16019	Pilot Pin 08050		Hi-broach 18 - 50 dia.
(TK00802)	Pilot Pin 0850		Jetbroach 17.5 - 50 dia.
TJ17436	Pilot Pin 08075	75	Jetbroach 17.5 - 50 dia.

※ (): SPECIAL ORDER

9-6 Ordering parts

Jetbroach One-touch Type 25L (metric sizes)

Part No.	Diameter × Depth
TK01148	12 × 25
TK01149	13 × 25
TK01150	14 × 25
TK01151	15 × 25
TK01152	16 × 25
TK01153	17 × 25

Jetbroach One-touch Type 35L (metric sizes)

Part No.	Diameter × Depth	Part No.	Diameter × Depth	Part No.	Diameter × Depth	Part No.	Diameter × Depth
TK00301	17.5 × 35	TK00310	22 × 35	TK00318	26.5 × 35	TK00326	34 × 35
TK00302	18 × 35	TK00311	22.5 × 35	TK00319	27 × 35	TK00328	35 × 35
TK00304	19 × 35	TK00312	23 × 35	TK00320	28 × 35	TK00602	36 × 35
TK00305	19.5 × 35	TK00313	23.5 × 35	TK00321	29 × 35	TK00603	37 × 35
TK00306	20 × 35	TK00314	24 × 35	TK00322	30 × 35	TK00604	38 × 35
TK00307	20.5 × 35	TK00315	24.5 × 35	TK00323	31 × 35	TK00605	39 × 35
TK00308	21 × 35	TK00316	25 × 35	TK00324	32 × 35	TK00606	40 × 35
TK00309	21.5 × 35	TK00317	26 × 35	TK00325	33 × 35		

Jetbroach One-touch Type 50L (metric sizes)

Part No.	Diameter × Depth	Part No.	Diameter × Depth	Part No.	Diameter × Depth	Part No.	Diameter × Depth
TK01154	12 × 50	TK00386	21 × 50	TK00398	28 × 50	TK00410	40 × 50
TK01155	13 × 50	TK00387	21.5 × 50	TK00399	29 × 50	TK00411	41 × 50
TK01156	14 × 50	TK00388	22 × 50	TK00400	30 × 50	TK00412	42 × 50
TK01157	15 × 50	TK00389	22.5 × 50	TK00401	31 × 50	TK00413	43 × 50
TK01158	16 × 50	TK00390	23 × 50	TK00402	32 × 50	TK00414	44 × 50
TK01159	17 × 50	TK00391	23.5 × 50	TK00403	33 × 50	TK00415	45 × 50
TK00380	17.5 × 50	TK00392	24 × 50	TK00404	34 × 50	TK00416	46 × 50
TK00381	18 × 50	TK00393	24.5 × 50	TK00405	35 × 50	TK00417	47 × 50
TK00382	19 × 50	TK00394	25 × 50	TK00406	36 × 50	TK00418	48 × 50
TK00383	19.5 × 50	TK00395	26 × 50	TK00407	37 × 50	TK00419	49 × 50
TK00384	20 × 50	TK00396	26.5 × 50	TK00408	38 × 50	TK00420	50 × 50
TK00385	20.5 × 50	TK00397	27 × 50	TK00409	39 × 50		

9-3 Supporting Magnet Ass'y

Part No.	Part Name
TB04374	Supporting Magnet Ass'y

9-4 Sleeve 6.5 Ass'y for twist drills (Fig. 34)

Part No.	Part Name
TB02536	Sleeve 6.5 Ass'y

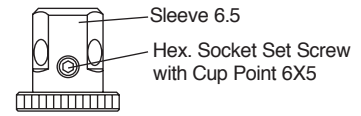

(Fig. 34)

9-5 Adapter Ass'y for Weldom shank cutters (Fig. 35)

Part No.	Part Name
TB05188	Adapter Ass'y

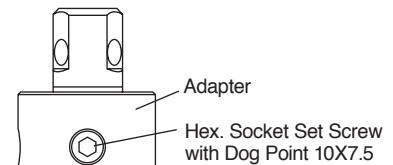

(Fig. 35)

Jetbroach One-touch Type 75L (metric sizes)

Part No.	Diameter × Depth	Part No.	Diameter × Depth	Part No.	Diameter × Depth	Part No.	Diameter × Depth
TK01036	17.5 × 75	TK01011	26 × 75	TK01020	35 × 75	TK01029	44 × 75
TK01003	18 × 75	TK01012	27 × 75	TK01021	36 × 75	TK01030	45 × 75
TK01004	19 × 75	TK01013	28 × 75	TK01022	37 × 75	TK01031	46 × 75
TK01005	20 × 75	TK01014	29 × 75	TK01023	38 × 75	TK01032	47 × 75
TK01006	21 × 75	TK01015	30 × 75	TK01024	39 × 75	TK01033	48 × 75
TK01007	22 × 75	TK01016	31 × 75	TK01025	40 × 75	TK01034	49 × 75
TK01008	23 × 75	TK01017	32 × 75	TK01026	41 × 75	TK01035	50 × 75
TK01009	24 × 75	TK01018	33 × 75	TK01027	42 × 75		
TK01010	25 × 75	TK01019	34 × 75	TK01028	43 × 75		

Hi-broach One-touch Type 25L (metric sizes)

Part No.	Diameter × Depth	Part No.	Diameter × Depth	Part No.	Diameter × Depth	Part No.	Diameter × Depth
TK00700	14 × 25	TK00342	22 × 25	TK00353	29 × 25	TK00708	40 × 25
TK00701	15 × 25	TK00343	22.5 × 25	TK00354	30 × 25	TK00709	41 × 25
TK00702	16 × 25	TK00344	23 × 25	TK00355	31 × 25	TK00710	42 × 25
TK00703	17 × 25	TK00345	23.5 × 25	TK00356	32 × 25	TK00711	43 × 25
TK00335	17.5 × 25	TK00346	24 × 25	TK00357	33 × 25	TK00712	44 × 25
TK00336	18 × 25	TK00347	24.5 × 25	TK00359	34 × 25	TK00713	45 × 25
TK00337	19 × 25	TK00348	25 × 25	TK00361	35 × 25	TK00714	46 × 25
TK00338	19.5 × 25	TK00349	26 × 25	TK00704	36 × 25	TK00715	47 × 25
TK00339	20 × 25	TK00350	26.5 × 25	TK00705	37 × 25	TK00716	48 × 25
TK00340	21 × 25	TK00351	27 × 25	TK00706	38 × 25	TK00717	49 × 25
TK00341	21.5 × 25	TK00352	28 × 25	TK00707	39 × 25	TK00718	50 × 25

Hi-broach One-touch Type 50L (metric sizes)

Part No.	Diameter × Depth	Part No.	Diameter × Depth	Part No.	Diameter × Depth	Part No.	Diameter × Depth
TK00723	14 × 50	TK00733	24 × 50	TK00743	34 × 50	TK00753	44 × 50
TK00724	15 × 50	TK00734	25 × 50	TK00744	35 × 50	TK00754	45 × 50
TK00725	16 × 50	TK00735	26 × 50	TK00745	36 × 50	TK00755	46 × 50
TK00726	17 × 50	TK00736	27 × 50	TK00746	37 × 50	TK00756	47 × 50
TK00727	18 × 50	TK00737	28 × 50	TK00747	38 × 50	TK00757	48 × 50
TK00728	19 × 50	TK00738	29 × 50	TK00748	39 × 50	TK00758	49 × 50
TK00729	20 × 50	TK00739	30 × 50	TK00749	40 × 50	TK00759	50 × 50
TK00730	21 × 50	TK00740	31 × 50	TK00750	41 × 50		
TK00731	22 × 50	TK00741	32 × 50	TK00751	42 × 50		
TK00732	23 × 50	TK00742	33 × 50	TK00752	43 × 50		

10 ATRA ACE WA-5000 MOTOR ASSEMBLY AND PARTS LIST

⚠ WARNING

The illustration is for information only. Users should never disassemble parts. Contact the sales agent from whom you purchased the tool or an authorized dealer should the tool need service, repair or replacement of parts.

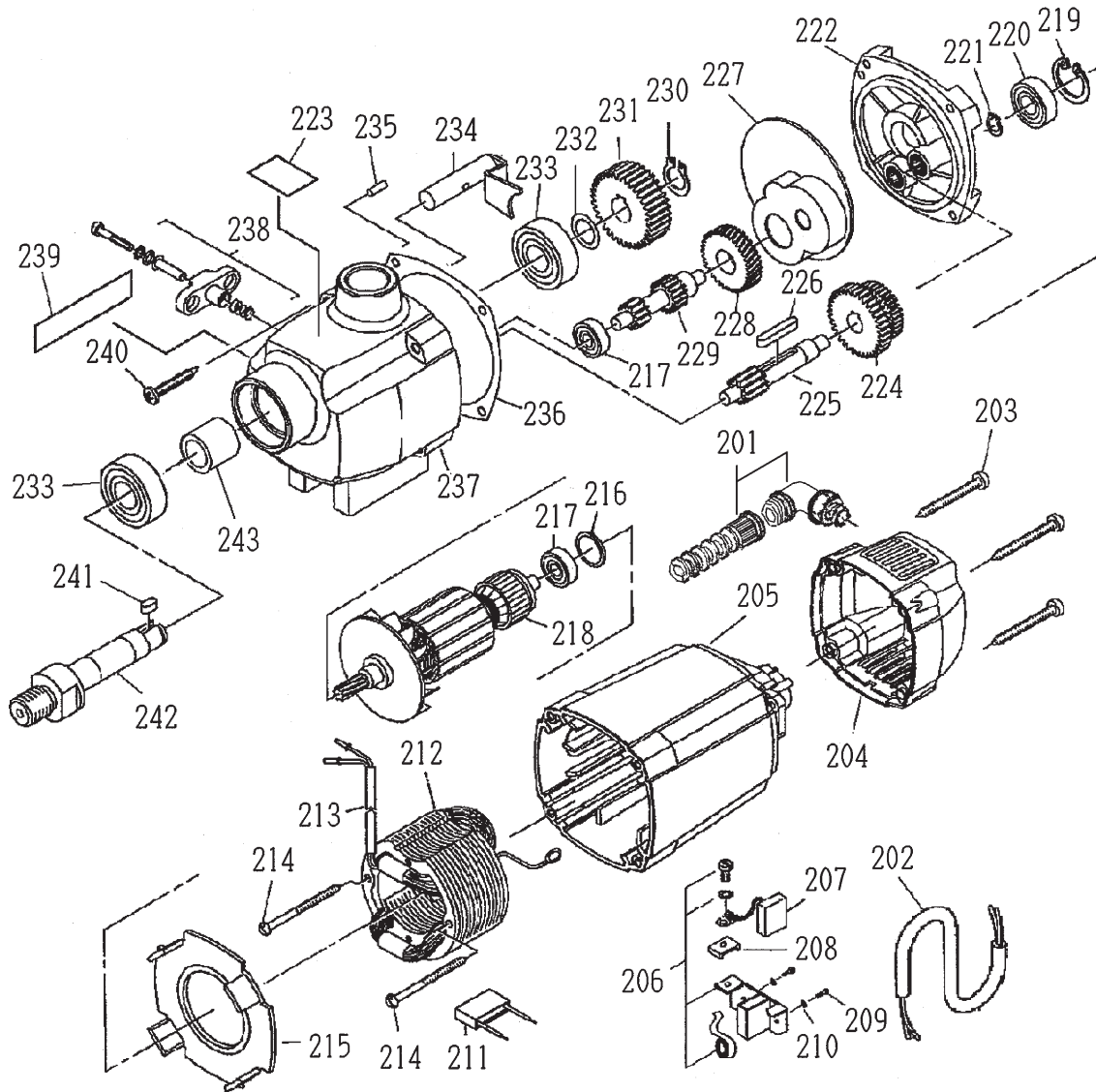

No.	Part No.	Part Name	Q'ty	Price
201	TQ06824	Cord Protector	1	
202	TQ06843	Connecting Cable	1	
203	TQ06819	Self Tapping Screw HC4.8 × 38	4	
204	TQ11172	Cap	1	
205	TQ06850	Motor Housing	1	
206	TB05193	Brush Holder Ass'y	1set	
207	TB05187	Carbon Brush Ass'y	1set	
208	TQ06838	Contact Washer	1	
209	TQ06828	Screw ZM4 × 12	2	
210	TQ06820	Spring Washer B4	2	
211	TQ06851	Condenser	1	
212	TB07200	Stator Ass'y (115V)	1set	
	TB07201	Stator Ass'y (230V)	1set	
213	TQ06852	Insulating Tubing	1	
214	TQ06849	Self Tapping Screw HC3.9 × 60	2	
215	TQ06848	Air Guiding Ring	1	
216	TQ06839	O-Ring 22 × 2.5	1	
217	TP00468	Ball Bearing 608ZZ	2	
218	TB07202	Armature Ass'y (115V)	1set	
	TB07203	Armature Ass'y (230V)	1set	
219	TP01036	Internal Retaining Ring C28	1	
220	TP00498	Ball Bearing 6001ZZ	1	

No.	Part No.	Part Name	Q'ty	Price
221	TP06390	External Retaining Ring C11	1	
222	TB05479	Bearing Bracket Ass'y	1set	
223	TQ10648	Label Caution Change	1	
224	TQ07076	Gear Block 34/40Z	1	
225	TQ07075	Pinion Shaft 13Z	1	
226	TQ07077	Key A5 × 5 × 28	1	
227	TQ06825	Grease Chamber	1	
228	TQ07069	Intermediate Gear 34Z	1	
229	TQ07070	Pinion Shaft 11/17Z	1	
230	CP04989	External Retaining Ring C15	1	
231	TQ07073	Spindle Gear 45Z	1	
232	TQ07074	Fitting Washer 15 × 22 × 0.2	1	
233	TQ06830	Ball Bearing 6203LLU	2	
234	TB05399	Coupling Bolt Ass'y	1set	
235	TQ06842	Notched Pin 4 × 12	1	
236	TQ06844	Gear Case Seal	1	
237	TB05478	Gear Case Ass'y	1set	
238	TB05398	Gear Changer Ass'y	1set	
239	TQ10647	Label Change Knob	1	
240	TQ12925	PT - Screw 5.0 × 50	4	
241	TQ07072	Key A5 × 5 × 12	1	
242	TQ07071	Spindle	1	
243	TQ11028	Collar	1	

⚠ WARNING

The illustration is for information only. Users should never disassemble parts. Contact the sales agent from whom you purchased the tool or an authorized dealer should the tool need service, repair or replacement of parts.

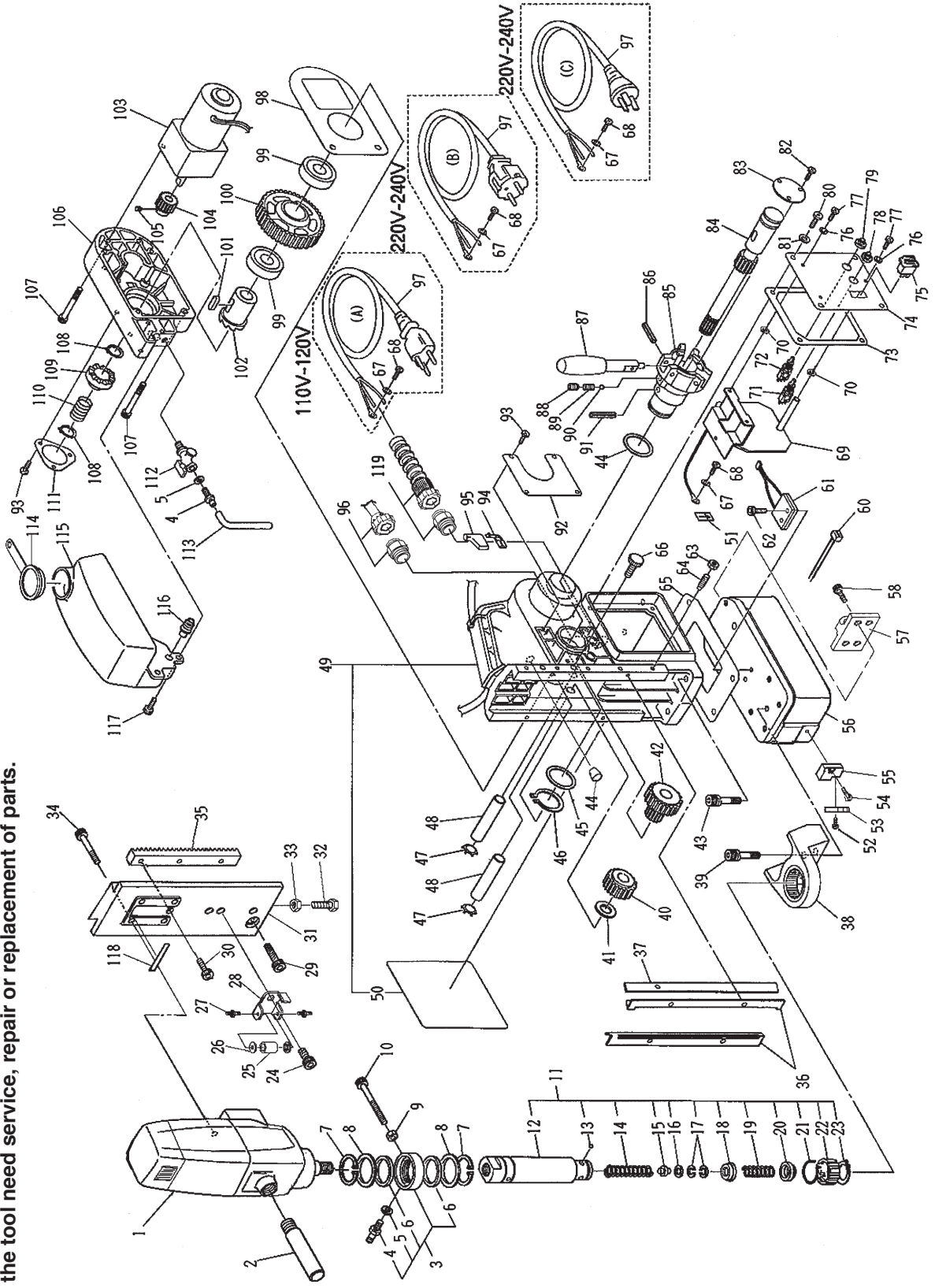

12 ATRA ACE WA-5000 PARTS LIST

The part numbers with () are included in the Ass'y parts written above them.

No.	Part No.	Part Name	Q'ty	Price
1	TB07169	Drill Motor Ass'y (110V-120V)	1set	
	TB07184	Drill Motor Ass'y (220V-240V)	1set	
-	(TB05187)	Carbon Brush Ass'y	1set	
2	TB02534	Slide Handle Ass'y	1set	
3	TB00496	Oil Ring Sub Ass'y	1set	
4	(P14500)	Hose Nipple	2	
5	(CP21947)	Packing S-4.7 x 8 x 0.8	2	
6	(P14499)	Oil Seal GD 38 x 48 x 4	2	
7	TP14989	External Retaining Ring ISTW-38	2	
8	TP12773	Washer 38.5 x 54 x 1	2	
9	LP10496	Hex. Nut M6	1	
10	TP05469	Hex. Socket Head Cap Screw 6 x 45	1set	
11	TB07172	Arbor Body Ass'y	1set	
12	(TQ10650)	Arbor Body	1	
13	(TB01672)	Ball 5/16 Ass'y	1set	
14	(TQ10649)	Spring 1.4 x 16.2 x 135	1	
15	(TQ01895)	Pilot Spacer	1	
16	(P15848)	Spacer 10.5 x 19 x 5	1	
17	(P13905)	Internal Retaining Ring RTW-19	2	
18	(TB01348)	Washer Ass'y	1set	
19	(TQ01898)	Spring 0.8 x 12 x 31	1	
20	(TB01349)	Push Ring Ass'y	1set	
21	(TQ01896)	Rotating Spring	1	
22	(TQ01897)	Sleeve	1	
23	(P15239)	External Retaining Ring C-28	1	
24	TP03247	Hex. Socket Head Cap Screw 10 x 15	1	
25	TQ00670	Dropper Pipe	1	
26	TQ00671	Dropper Packing	2	
27	TQ00672	Dropper Nipple	2	
28	TQ10785	Dropper Plate	1	
29	TP14174	Hex. Socket Head Cap Screw 10 x 25	3	
30	TP01945	Hex. Socket Head Cap Screw 5 x 12	1	
31	TQ10646	Slide Board	1	
32	TQ10849	Hex. Bolt 8 x 20	1	
33	TP08584	Hex. Nut M8	1	
34	TP04532	Hex. Socket Head Cap Screw 5 x 30	4	
35	TP12776	Rack	1	
36	TP12777	Slide Plate	2	
37	TQ06773	Gib	1	
38	TB05407	Bracket Ass'y	1set	
39	TQ03346	Hex. Socket Head Cap Screw 8 x 30 with Spring Washer	3	
40	TQ06775	Spur Gear 1.5 x 26	1	
41	TQ06779	Washer 12.2 x 28 x 1	1	
42	TQ06774	Spur Gear 1.5 x 14 x 29	1	
43	TQ03345	Hex. Socket Head Cap Screw 8 x 25 with Spring Washer	4	
44	TQ10791	Rubber Stopper	1	
45	TQ06780	Washer 32.2 x 42 x 2	2	
46	TQ06781	External Retaining Ring ISTW-32	1	
47	TQ04715	Internal Retaining Ring CRTW-12	2	
48	TQ06776	Shaft	2	
49	TB08779	Body Sub Ass'y	1set	
50	(TB12858)	Label Warning	1	
51	(LP13557)	Label Earth	1	
52	TP01945	Hex. Socket Head Cap Screw 5 x 12	1	
53	TQ10787	Blade	1	

No.	Part No.	Part Name	Q'ty	Price
54	TP14178	Hex. Socket Head Cap Screw 6 x 10	1	
55	TQ10695	Blade Base	1	
56	TB07174	Square Pole Ass'y (110V-120V)	1set	
57	TB07185	Square Pole Ass'y (220V-240V)	1set	
57	TP17985	Chain Guide	1	
58	TP01644	Hex. Socket Head Cap Screw 6 x 12	4	
60	TB00573	D Cord Ass'y	1set	
61	TB01363	Side Slip Deflection Function Ass'y	1set	
62	TQ10600	Hex. Socket Head Cap Screw 4 x 18	2	
63	TP07419	Hex. Nut Type3 M6	5	
64	TQ00730	Hex. Socket Set Screw with Dog Point 6 x 20	5	
65	TQ06794	Packing Pole	1	
66	TP02931	Set Screw	1	
67	TP04464	Toothed Lock Washer B M4	2	
68	LP08489	Binding Head Screw 4 x 6	2	
69	TB07214	Control Board Ass'y (110V-120V)	1set	
70	TP09422	O-Ring P-3	3	
71	TB07055	Switch SW3 Ass'y	1set	
72	TB07054	Switch SW2 Ass'y	1set	
73	TQ06787	Packing Body	1	
74	TQ10654	Switch Plate	1	
75	TQ07306	Rocker Switch	1	
76	TQ00258	Seal Washer M4	3	
77	TQ01526	Pan Head Screw 4 x 10	3	
78	TQ10085	Waterproofing Cap Black	1	
79	TQ10467	Waterproofing Cap Red	1	
80	TP02419	Pan Head Screw 6 x 10	4	
81	TQ01331	Seal Washer M6	4	
82	TP08598	Pan Head Screw 3 x 5	3	
83	TQ00762	Plate Automatic Feeder	1	
84	TQ06760	Gear Shaft	1	
85	TQ06761	Handle Stem	1	
86	TP12821	Spring Pin 5 x 26 AW Double	3	
87	TQ00680	Rod Handle	3	
88	TP06397	Hex. Socket Set Screw with Cup Point 6 x 8	3	
89	TP06396	Spring	3	
90	CP01123	Ball 3/16	3	
91	TQ06759	Spring Pin 8 x 40 AW	1	
92	TQ12884	Plate Spec. (110V-120V)	1	
93	TP12819	Pan Head Screw 4 x 6	7	
94	TQ07308	Terminal #250 42232-3	2	
95	TQ07309	Sleeve 170891-1	2	
96	TQ07097	Cable Connector 3217	1	
	TB05877	Cable Cord Ass'y (A) (110V-120V)	1set	
	TB05896	Cable Cord Ass'y (B) (220V-240V)	1set	
	TB04482	Cable Cord Ass'y (C) (220V-240V)	1set	
98	TQ06782	Packing Gear Box	1	
99	TQ06766	Ball Bearing 6906ZZ	2	
100	TQ06764	Spur Gear 1 x 88	1	
101	TQ06765	Parallel Key 8 x 7 x 20 Both ends round	1	
102	TQ06763	Clutch B	1	
103	TQ06767	Gear Motor	1	
104	TQ06768	Spur Gear 1 x 23	1	

Accessories

No.	Part No.	Part Name	Q'ty	Price
-	TP04696	Hex. Socket Screw Key 3	1	
-	TP01939	Hex. Socket Screw Key 4	1	
-	TP17014	Spanner 8 x 10	1	
-	TJ16019	Pilot Pin 08050	1set	
-	TA99027	Chain Ass'y	1set	
-	TB02145	Cutting Oil 0.5L Ass'y	1set	
-	TB05418	Guard Ass'y	1set	
-	TQ12850	Instruction Manual	1	

No.	Part No.	Part Name	Q'ty	Price
105	CP26427	Hex. Socket Set Screw with Cup Point 5 x 6	1	
106	TQ06769	Gear Box	1	
107	TQ06770	Hex. Socket Head Cap Screw 4 x 35	8	
108	TP06387	External Retaining Ring GV-16	2	
109	TP12325	Clutch A	1	
110	TP06374	Spring	1	
111	TQ06777	Cover Plate	1	
112	TP14495	P-Valve PT1/8	1	
113	TB01098	Tube 4 x 7 x 3000 Ass'y (150mm x 2)	1set	
114	TQ06785	Rubber Cap	1	
115	TQ06784	Oil Tank	1	
116	TQ06786	Rubber Plug	1	
117	TP04715	Hex. Socket Head Cap Screw 4 x 8	3	
118	TQ11027	Shim 0.2	1	
119	TQ11075	Cable Connector 3247	1	

